

19 826 Trim, Volume Control

Exploded View

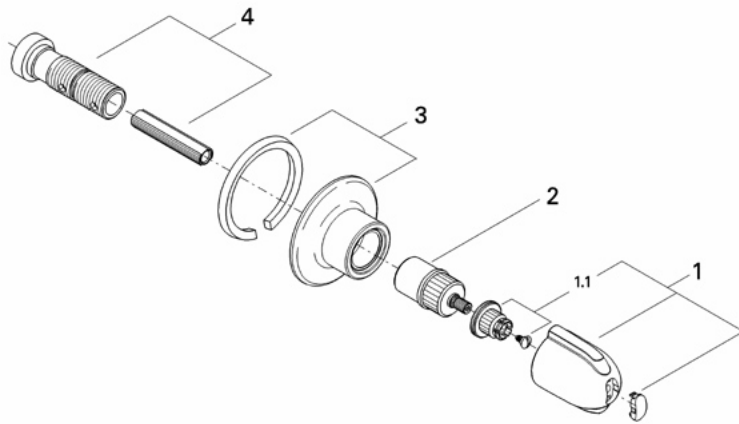

Parts Breakdown

Pos No.	Spare Part Description	Product No.	Pcs.
	19 826		
1	Handle	47 522	1
1.1	Handle connection set	45 186	1
2	Secondary spindle/low profile	45 204	1
3	Escutcheon	47 523	1
4	Primary spindle	45 202	1
	Special Accessories		
	Extension kit for vol.controls	45 203	1